



Arik Levy designed *Tea Time*, a modular sofa system where dynamism and rationality are the distinctive elements. *Tea Time* does not impose defined, pre-constructed volumes. It “reads” the room dynamically, expressing itself fully through the realm of modular possibilities. Different sized seats arranged together produce free compositions or completed sofas.

■ Finishes

Cover

fabric
leather

Feet

shiny chrome
black chrome

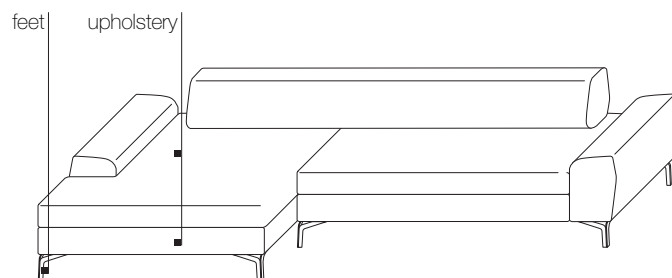

Arik Levy Arik Levy, born 1963 in Tel Aviv, Israel, studied industrial design at Art Center College of Design in La Tour de Peilz, Switzerland. He taught at the École Nationale Supérieure de Création Industrielle / Les Ateliers, Paris, and led design workshops at various design schools in Europe. At the same time he created stage sets for modern dance performances at the Grand Theatre in Geneva, for the Netherlands Dance Theatre, the Finnish National Ballet and the BatSheva Dance Centre in Israel. In 1997, he co-founded the firm “L design” with Pippo Lionni.

■ Dimensions

Sofas

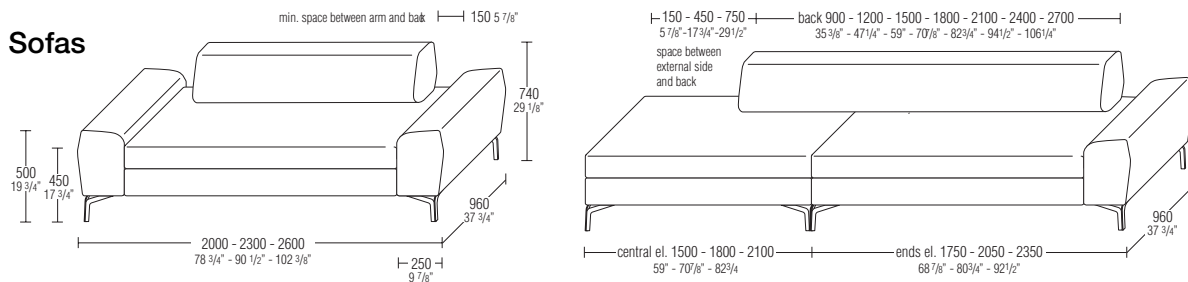

Chaise longue

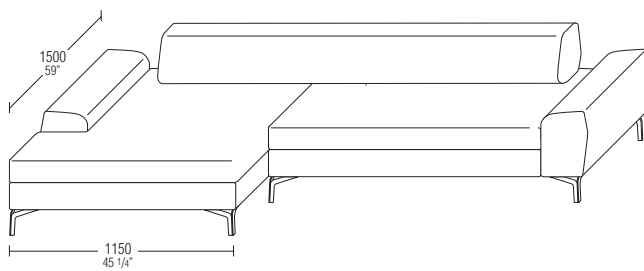

End elements

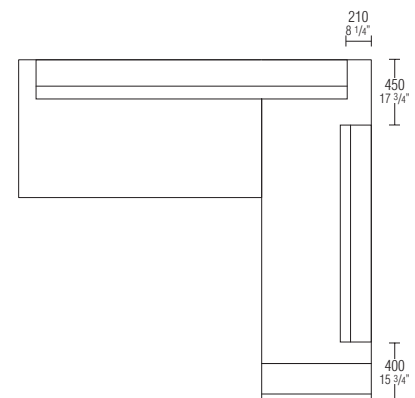

■ Elements

sofa

W 2000 D 960 H 740
W 78 3/4" D 37 3/4" H 29 1/8"
back W 1200 - 47 1/4"

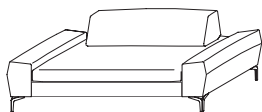

D200

sofa

W 2300 D 960 H 740
W 90 1/2" D 37 3/4" H 29 1/8"
back W 1500 - 59"

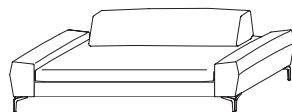

D230

sofa

W 2600 D 960 H 740
W 102 3/4" D 37 3/4" H 29 1/8"
back W 1800 - 70 7/8"

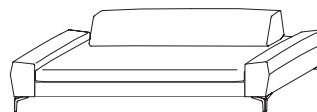

D260

sofa

W 3500 D 960 H 740
W 137 3/4" D 37 3/4" H 29 1/8"
back W 2700 - 106 1/4"

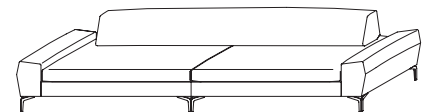

D1

island element

W 3250 D 960 H 740
W 128" D 37 3/4" H 29 1/8"
single back W 2100 - 82 3/4"



IS2 dx-sx

island element

W 3550 D 960 H 740
W 139 3/4" D 37 3/4" H 29 1/8"
single back W 2400 - 94 1/2"

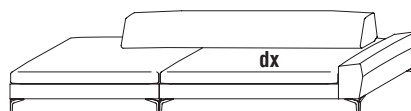

IS3 dx-sx

pouf

W 1200 D 1200 H 380
W 47 1/4" D 47 1/4" H 15"



PF120

pouf

W 1500 D 600 H 380
W 59" D 23 5/8" H 15"



PF150



CT50

additional cushion
W 500 H 500
W 19 3/4" H 19 3/4"



CT40

additional cushion
W 500 H 400
W 19 3/4" H 15 3/4"